

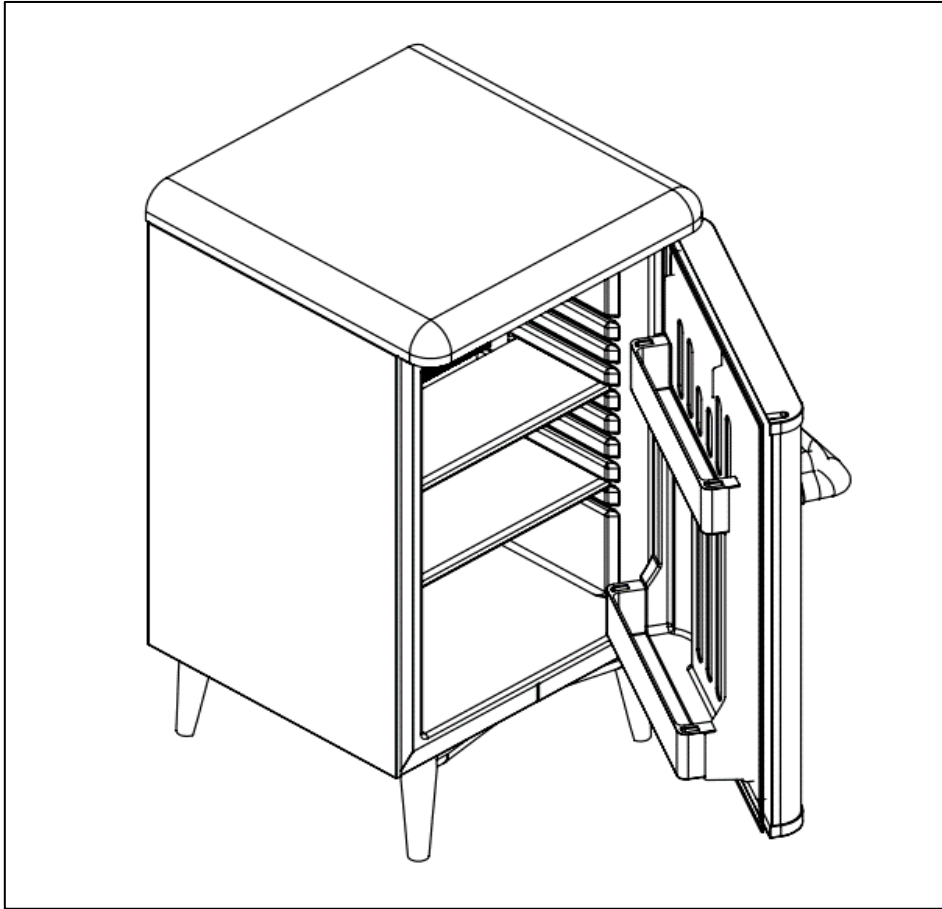

**Bädd & Bad AB**  
Grustagsgatan 22  
254 64 Helsingborg, Sweden  
Tel. +46 42 26 66 60

Revizyon no / Revision no : 02  
Revizyon tarihi / Revision date : 22.04.2024  
Model: SM 521-TH -RETRO

## TECHNICAL SPECIFICATIONS



---

**MODEL: 81914467**

# TECHNICAL DATA SHEET

## CHARACTERISTICS

➤ Compartment Type	: Cellar/ Killer
➤ Energy Efficient Class	: G
➤ Climate Class	: N
➤ Energy Consump.	: 117 (KWh per year)
➤ Energy Efficiency Index	: 150 %
➤ Power	: 50 W
➤ Voltage / Freq.	: 110 V - 240 V / 50-60 Hz.
➤ Defrosting Type	: Automatic
➤ Noise Emission	: 23 (dB(A) re 1 pW)

## ACCESSORIES

➤ Internal Light	: Standart
➤ Thermostat Control	: Opsiyonel
➤ Ayak	: Opsiyonel

## TECHNICAL SPECIFICATIONS

➤ External Dims.	: 785X436X493 mm (HxWxD)
➤ Internal Dims.	: 526X352X200 mm (HxWxD)
➤ Pack. Dims.	: 745X490X540
➤ Pack. Volume	: 0,151 m <sup>3</sup>
➤ Net Volume	: 38 lt
➤ Total Volume	: 43 lt
➤ Gross Weight	: 20,5 kg
➤ Net Weight	: 18 kg
➤ Outer Body	: 0.4 mm.PVC Kaplı Sac / 0,4 PVC Cooted Sheet
➤ Inner Liner	: Hips
➤ Insulation Material	: Sert P.U. / Rigid P.U.
➤ Blowing Agent	: C.Pentane
➤ Insulation Density	: 38~40 kg/m <sup>3</sup>